

HEAT CONTROLLER, INC.

REMOTE CONTROLLER OWNER'S MANUAL

B-SMA/SMH 09/12/18SC

Single Zone Mini-Splits

B-VMH 09/12/18/24/30/36SC-1

Single Zone Inverter Mini-Splits

B-VMH09/12/18FC-1

Multi-Flex Inverter Mini-Splits

Table of Contents

Using the remote controller	2
Remote controller specifications.....	3
Function buttons	4
Indicators on LCD display.....	6
How to use the buttons.....	7
Auto operation	7
Cooling/Heating/Fan operation.....	7
Dehumidifying operation.....	8
Swing operation.....	8
Timer operation	9
Economy operation.....	12

Using the Remote Controller

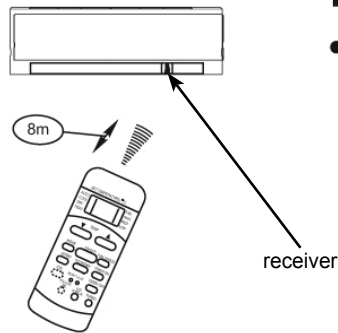

Location of the remote controller.

- Use the remote controller within a distance of 26' 3" (8 meters) from the appliance, pointing it towards the receiver. Reception is confirmed by a beep.

⚠ CAUTIONS

- The air conditioner will not operate if curtains, doors or other materials block the signals from the remote controller to the indoor unit.
- Prevent any liquid from falling into the remote controller. Do not expose the remote controller to direct sunlight or heat.
- If the infrared signal receiver on the indoor unit is exposed to direct sunlight, the air conditioner may not function properly. Use curtains to prevent the sunlight from falling on the receiver.
- If other electrical appliances react to the remote controller, either move these appliances or consult your local dealer.

Replacing batteries

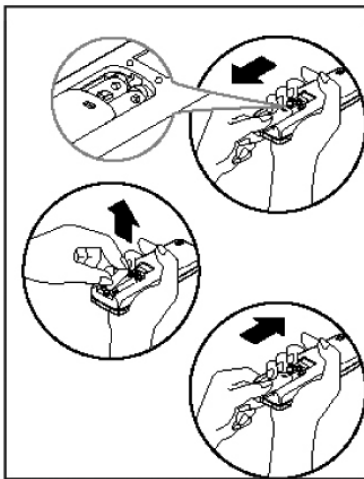

The remote controller is powered by two dry batteries (AAA 1.5V) housed in the rear housing and protected by a cover.

- (1) Remove the battery cover by pressing and sliding it off.
- (2) Remove the old batteries and insert the new batteries, placing the (+) and (-) ends correctly.
- (3) Reattach the cover by sliding it back into position.

NOTE: When the batteries are removed, the remote controller erases all programming. After inserting new batteries, the remote controller must be reprogrammed.

▲ CAUTIONS

- Do not mix old and new batteries or batteries of a different type.
Do not leave the batteries in the remote controller if it is not going to be used for an extended period of time.

Remote Controller Specifications

Model*	R51I5BG(C)E, R51I6/BG(C)E, R51I7/BG(C)E, R51I8/BG(C)E, R51I9/BG(C)E; R51I10/BG(C)E, R51I11/BG(C)E, R51I12/BG(C)E;
Rated Voltage	3.0V (Dry batteries R03/LR03x2 or (2) AAA)
Lowest Voltage of CPU Emitting Signal	2.0V
Signal Receiving Range	26'3" (8m)
Environment	-41°F~140°F (-5°C~60°C)

NOTE:*Temperature setting display:**

Fahrenheit scale (°F): R51I9/BG(C)E; R51I10/BG(C)E, R51I11/BG(C)E, R51I12/BG(C)E

Celsius scale (°C): R51I5BG(C)E, R51I6/BG(C)E, R51I7/BG(C)E, R51I8/BG(C)E

Performance Feature

1. Operating Mode: AUTO, COOL, DRY, HEAT(Cooling only model without), and FAN.
2. Timer Setting Function in 24 hours.
3. Indoor setting temperature range: 62°F~88°F (17°C~30°C)
4. Full function of LCD Display (Liquid Crystal Display)
5. Back light emitting.

Function Buttons

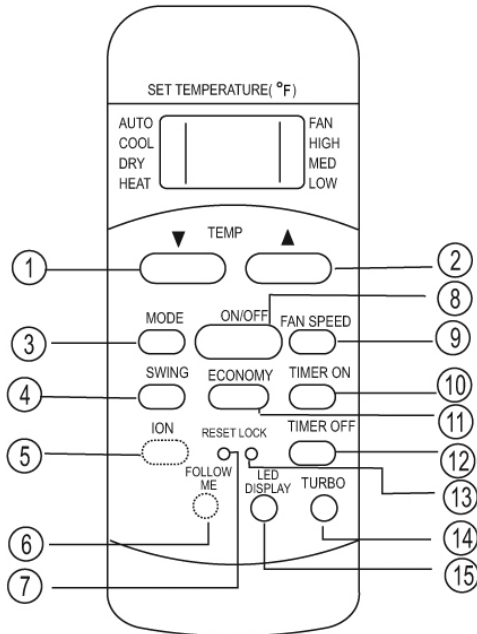

ION and FOLLOW buttons are optional functions.

1 TEMP UP Button

Push this button to increase the indoor temperature setting in 2°F(1°C) increments to 88°F(30°C).

2 TEMP DOWN Button

Push this button to decrease the indoor temperature setting in 2°F(1°C) increments to 62°F(17°C).

3 MODE Button

Each time the button is pressed, the operation mode is selected in the sequence of the following:

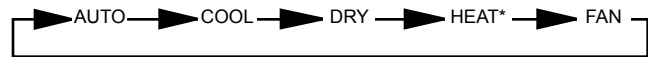

*NOTE: Heat pump models only

4 SWING Button

Used to stop or start louver movement and set the desired up/down airflow direction.

5 ION Button(Optional)

When push this button, the ion generator is energized and will help to remove pollen and impurities from the air.

6 FOLLOW ME Button(Optional)

Push this button to initiate the Follow Me function, the remote controller begins to detect the actual temperature at its location. The remote controller will send this signal to the air conditioner every 3 minutes interval until press the Follow Me button again. The air conditioner will beep to indicate the Follow Me feature has ended if it does not receive the signal during any 7 minute interval.

7 RESET Button

Once the recessed RESET button is pressed, all of the current settings will be cancelled and the controller will return to the initial settings.

8 ON/OFF Button

Operation starts when this button is pressed and stops when the button is pressed again.

9 FAN SPEED Button

Used to select the fan speed in four steps:

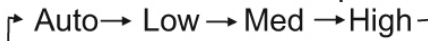

Function Buttons (continued)

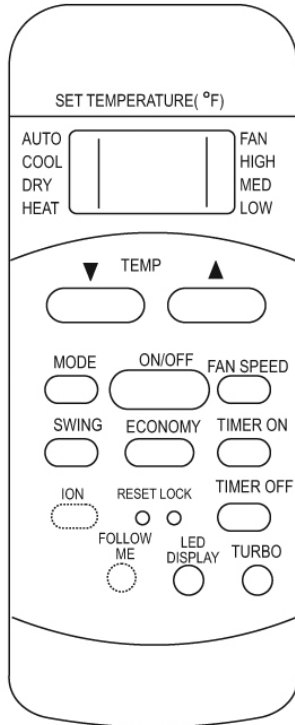

ION and FOLLOW buttons are optional functions.

10 TIMER ON Button

Press this button to activate the Auto-on time setting. Each press will increase the time setting in 30 minutes increments, up to 10 hours, then at 1 hour increments up to 24 hours. To cancel the Auto-on time setting, just press the button until the time setting is 0.0.

11 ECONOMY Button (Sleep Mode)

Select this function during the sleeping time. It to maintain the most comfortable temperature and save energy. This function is available on COOL, HEAT or AUTO mode only .

NOTE: While the unit is running under Energy-saving mode, it would be cancelled if any other buttons are pressed.

12 TIMER OFF Button

Press this button to activate the Auto-off time setting. Each press will increase the time setting in 30 minutes increments, up to 10 hours, then at 1 hour increments up to 24 hours. To cancel the Auto-off time setting, just press the button until the time setting is 0.0.

13 LOCK Button

Press this recessed button to lock all current settings. Use the LOCK mode when you want to prevent settings from being changed accidentally. Press the LOCK button again to cancel the LOCK function. A key symbol will appear on the remote controller display when the lock function is activated.

14 Turbo Button

Used to start or stop the speed cooling/heating. Speed cooling/heating operates super high fan speed in cooling/heating mode.

Note: The unit system will automatically revert back to the previous settings after continue operating under speed cooling mode for about 20 minutes.

15 LED Display Button

Press this button to clear the display on the indoor unit, press it again to light the display .

Indicators on LCD Display

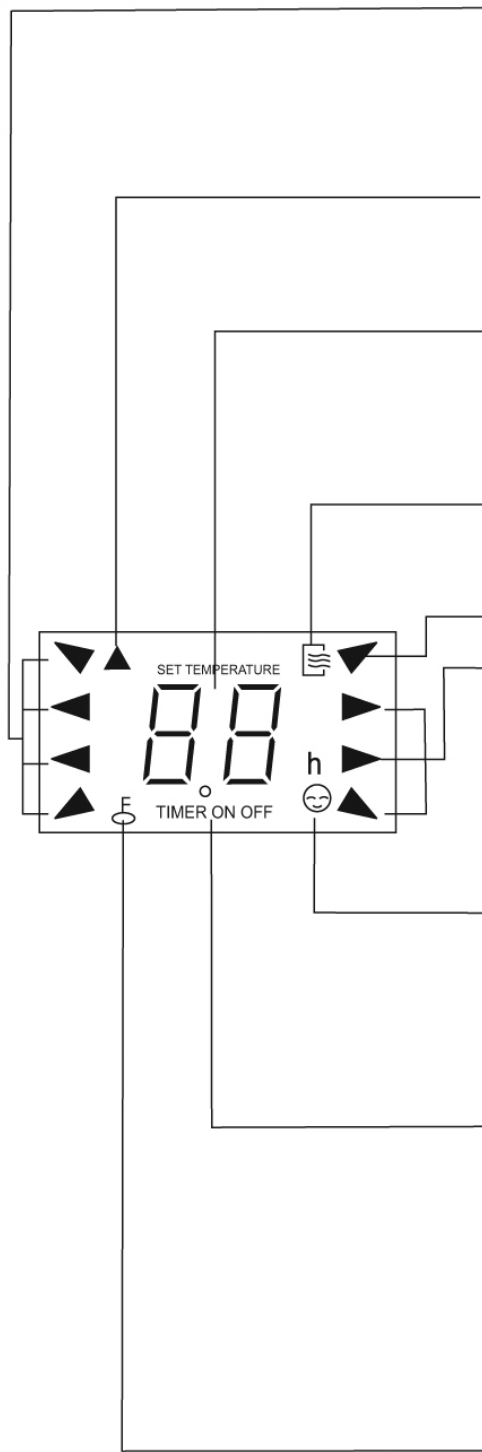

MODE display

Displays the current selected mode. Including AUTO, COOL, DRY, HEAT (cooling & heating models only) and FAN.

Transmission Indicator

This transmission indicator will light when remote controller transmits signals to the indoor unit.

Temp./Timer display

The temperature setting (from 62°F (17°C) to 88°F (30°C)) or timer setting (0~24h) will be displayed. If FAN mode is selected, there will be no display.

ON/OFF display

This indicator will be displayed when the unit is operating.

MODE display(FAN mode)

FAN SPEED display

Displays the selected fan speed: AUTO, HIGH, MED and LOW. Nothing displays when the fan speed is selected in AUTO speed. When AUTO or DRY Mode is selected, there will be no signals displayed.

FOLLOW ME display(on some models)

When pressing FOLLOW ME button in COOL or HEAT mode, the remote sensing function is activated and this indicator displays.

TIMER display

This display area shows the settings of the TIMER. That is, if only the Auto-on time function is set, it will display TIMER ON. If only the Auto-off time function is set, it will display TIMER OFF. If both functions are set, it will display TIMER ON OFF which indicates you have chosen both the Auto-on time and Auto-off time.

LOCK Indicator

A key symbol is displayed when pushing the LOCK button. Push the LOCK button to clear display.

How to use the buttons

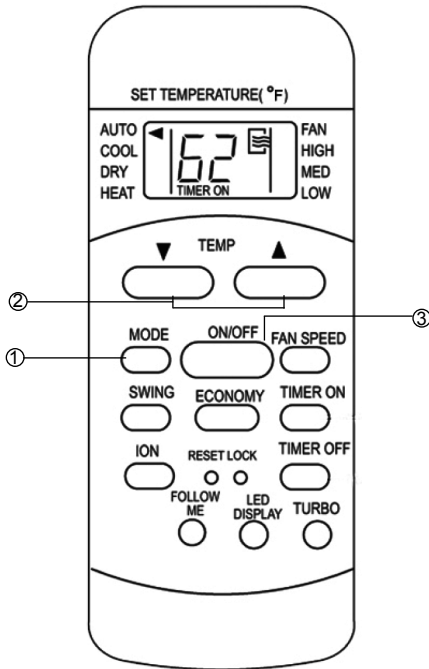

Auto operation

Ensure power is available to the unit. The OPERATION indicator on the display panel of the indoor unit illuminates.

1. Press the **MODE** button to select Auto.
2. Press the **TEMP** button to set the desired temperature. The temperature can be set within a range of 62°F (17°C)~88°F (30°C) in 2°F (1°C) increments.
3. Press the **ON/OFF** button to start the air conditioner.

NOTE

1. In the Auto mode, the air conditioner can logically choose the mode of Cooling, Fan, Heating and Dehumidifying by sensing the difference between the actual ambient room temperature and the set temperature on the remote controller.
2. In the Auto mode, you can not switch the fan speed. It is automatically controlled in this mode.
3. If the Auto mode is not comfortable for you, the desired mode can be selected manually.

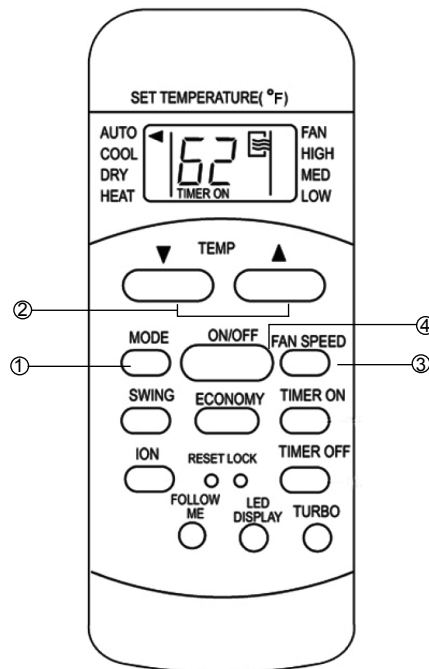

Cooling/Heating/Fan Operation

Ensure power is available to the unit.

1. Press the **MODE** button to select COOL, HEAT (cooling & heating models only), or FAN mode.
2. Press the **TEMP** button to set the desired temperature. The temperature can be set with a range of 62°F (17°C)~88°F (30°C) in 2°F (1°C) increments.
3. Press the **FAN SPEED** button to select the fan speed in four steps—Auto, Low, Med or High.
4. Press the **ON/OFF** button to start the air conditioner.

NOTE

In the FAN mode, the setting temperature is not displayed in the remote controller. In fan only mode, the fan creates a breeze without cooling or heating the room. To cool or heat the room, cooling or heating modes need to be selected rather than fan only.

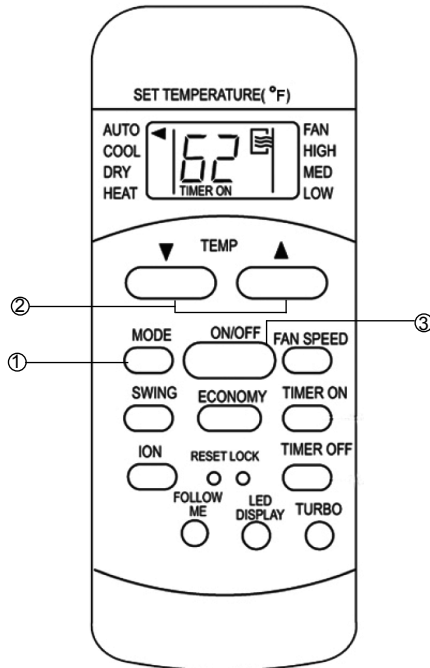

Dehumidifying operation

Ensure power is available to the unit. The OPERATION indicator on the display panel of the indoor unit illuminates.

1. Press the **MODE** button to select DRY mode.
2. Press the **TEMP** button to set the desired temperature. The temperature can be set within a range of 62°F (17°C)~88°F (30°C) in 2°F (1°C) increments.
3. Press the **ON/OFF** button to start the air conditioner.

NOTE

In the Dehumidifying mode, you can not switch the fan speed as it is being automatically controlled.

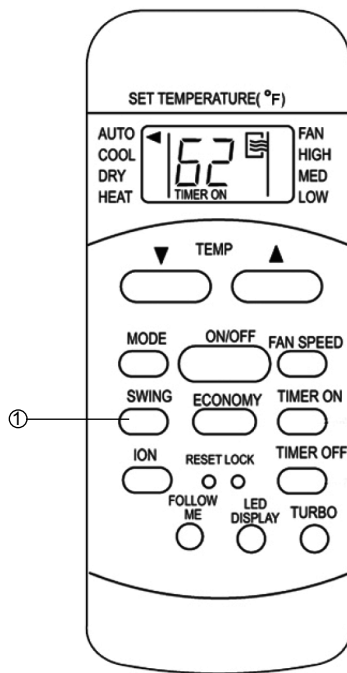

Swing operation

Use the SWING button to adjust the Up/Down airflow direction.

1. When the SWING button is pressed once, the air flow direction setting feature of the louver is activated. The angle of the louver changes by 6° each time the button is pressed. Keep pressing the button to move the louver to the desired position.
2. By pressing the SWING button without releasing it for 2 seconds, the auto swing feature of the louver activates. The horizontal louver swings up/down automatically. Press it again to stop.

NOTE

When the louver moves to a position which would affect the cooling and heating effect of the air conditioner, it will automatically change the swing/louver direction.

Timer operation

Pressing the TIMER ON button can set the auto-on time of the unit. And pressing the TIMER OFF button can set the auto-off time of the unit.

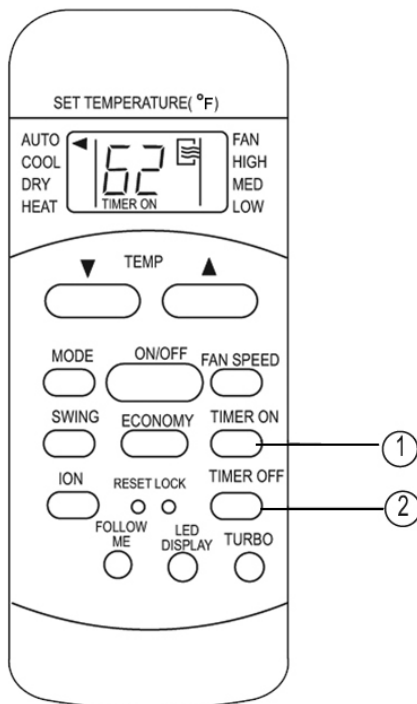

To set the Auto-on time.

1. Press the TIMER ON button. The remote controller shows TIMER ON, the last Auto-on setting time and the symbol "h" will be shown on the LCD display area. Now it is ready to reset the Auto-on time.
2. Push the TIMER ON button again to set desired Auto-on time. Each time you press the button, the time increases in 30 minutes increments, up to 10 hours, then at 1 hour increments up to 24 hours. **SEE NOTE.**
3. After setting the TIMER ON, there will be a one-half second delay before the remote controller transmits the signal to the air conditioner. Then, after approximately another 2 seconds, the signal "h" will disappear and the set temperature will re-appear on the LCD display window.

To set the Auto-off time.

1. Press the TIMER OFF button. The remote controller shows TIMER OFF, the last Auto-off setting time and the symbol "h" will be shown on the LCD display area. Now it is ready to reset the Auto-off time to START the operation.
2. Push the TIMER OFF button again to set desired Auto-off time. Each time you press the button, the time increases in 30 minutes increments, up to 10 hours, then at 1 hour increments up to 24 hours. **SEE NOTE ON NEXT PAGE.**
3. After setting the TIMER OFF, there will be a one-half second delay before the remote controller transmits the signal to the air conditioner. Then, after approximately another 2 seconds, the symbol "h" will disappear and the set temperature will re-appear on the LCD display window.

NOTE:

The time set by the remote controller for the timer function is limited to the following settings, shown in hours as follows: 0.5, 1.0, 1.5, 2.0, 2.5, 3.0, 3.5, 4.0, 4.5, 5.0, 5.5, 6.0, 6.5, 7.0, 7.5, 8.0, 8.5, 9.0, 9.5, 10, 11, 12, 13, 14, 15, 16, 17, 18, 19, 20, 21, 22, 23 and 24.

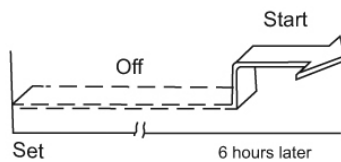
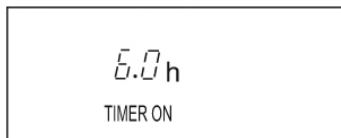
Example of Timer setting**TIMER ON
(Auto-on Operation)**

The TIMER ON feature is useful when you want the unit to turn on automatically before say when you return home. The air conditioner will automatically start operating at the set time.

Example:

To start the air conditioner in 6 hours.

1. Press the TIMER ON button, the last setting of starting operation time and the symbol "h" will show on the display area.
2. Press the TIMER ON button to display "6:0h" on the TIMER ON display of the remote controller.
3. Wait for 0.5 second and the TIMER ON indicator stops flashing and this function is activated. The digital display area will show the temperature again.

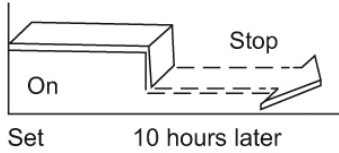
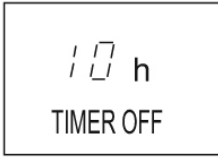

TIMER OFF

(Auto-off Operation)

The TIMER OFF feature is useful when you want the unit to turn off automatically after you go to bed. The air conditioner will stop automatically at the set time.

Example:

To stop the air conditioner in 10 hours.

1. Press the TIMER OFF button, the last setting of stopping operation time and the symbol "h" will show on the display area.
2. Press the TIMER OFF button to display "10h" on the TIMER OFF display of the remote controller.
3. Wait for 0.5 second and the TIMER OFF indicator stops flashing and this function is activated. The digital display area will show the temperature again.

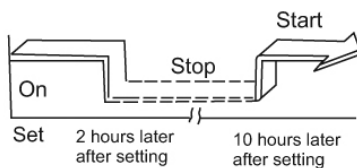

COMBINED TIMER

(Setting both ON and OFF timers simultaneously)

TIMER OFF → TIMER ON

(On → Stop → Start operation)

This feature is useful when you want to stop the air conditioner after you go to bed, and start it again in the morning when you wake up or when you return home.

Example:

To stop the air conditioner 2 hours after setting and start it again 10 hours after setting.

1. Press the TIMER OFF button.
2. Press the TIMER OFF button again to display 2.0h on the TIMER OFF display.
3. Press the TIMER ON button.
4. Press the TIMER ON button again to display 10h on the TIMER ON display .
5. Wait for the remote control to display the setting temperature.

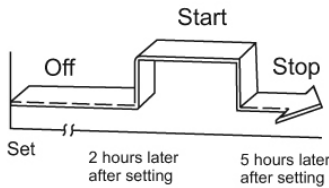

TIMER ON → TIMER OFF

(Off → Start → Stop operation)

This feature is useful when you want to start the air conditioner before you wake up and stop it after you leave the house.

Example:

To start the air conditioner 2 hours after setting, and stop it 5 hours after setting.

1. Press the TIMER ON button.
2. Press the TIMER ON button again to display 2.0h on the TIMER ON display.
3. Press the TIMER OFF button.
4. Press the TIMER OFF button again to display 5.0h on the TIMER OFF display .
5. Wait for the remote control to display the setting temperature.

CAUTION

- The timer setting(TIMER ON or TIMER OFF) that in sequence occurs directly after the set time will be activated first.

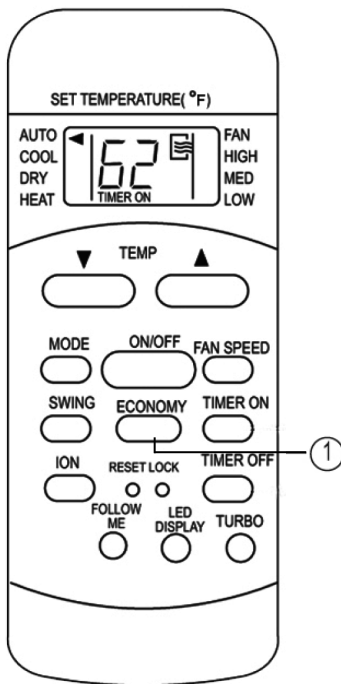

ECONOMY (SLEEP MODE) operation

When you press the ECONOMY button, the economy/sleep mode running function will be activated, the set temperature will increase (in cooling) or decrease (in heating mode) by 2°F (1°C) over the next 30 minutes and by another 2°F (1°C) after an additional 30 minutes. This new temperature will be maintained for 7 hours before it returns to the originally selected temperature. (NOTE: On some models, the set temperature will increase (cooling) or decrease (heating) by 2°F (1°C) per hour for 2 hours. This new temperature will be maintained for 5 hours, then the unit turns off.)

NOTE: The ECONOMY/SLEEP function is only available under Cooling, Heating and Auto operation.

Design, material, performance data and components
subject to change without notice.

HEAT CONTROLLER, INC.

1900 Wellworth Ave., Jackson, MI 49203 • Ph. 517-787-2100 • Fax 517-787-9341

THE QUALITY LEADER IN CONDITIONING AIR

www.heatcontroller.com